

Cavity Type C0820

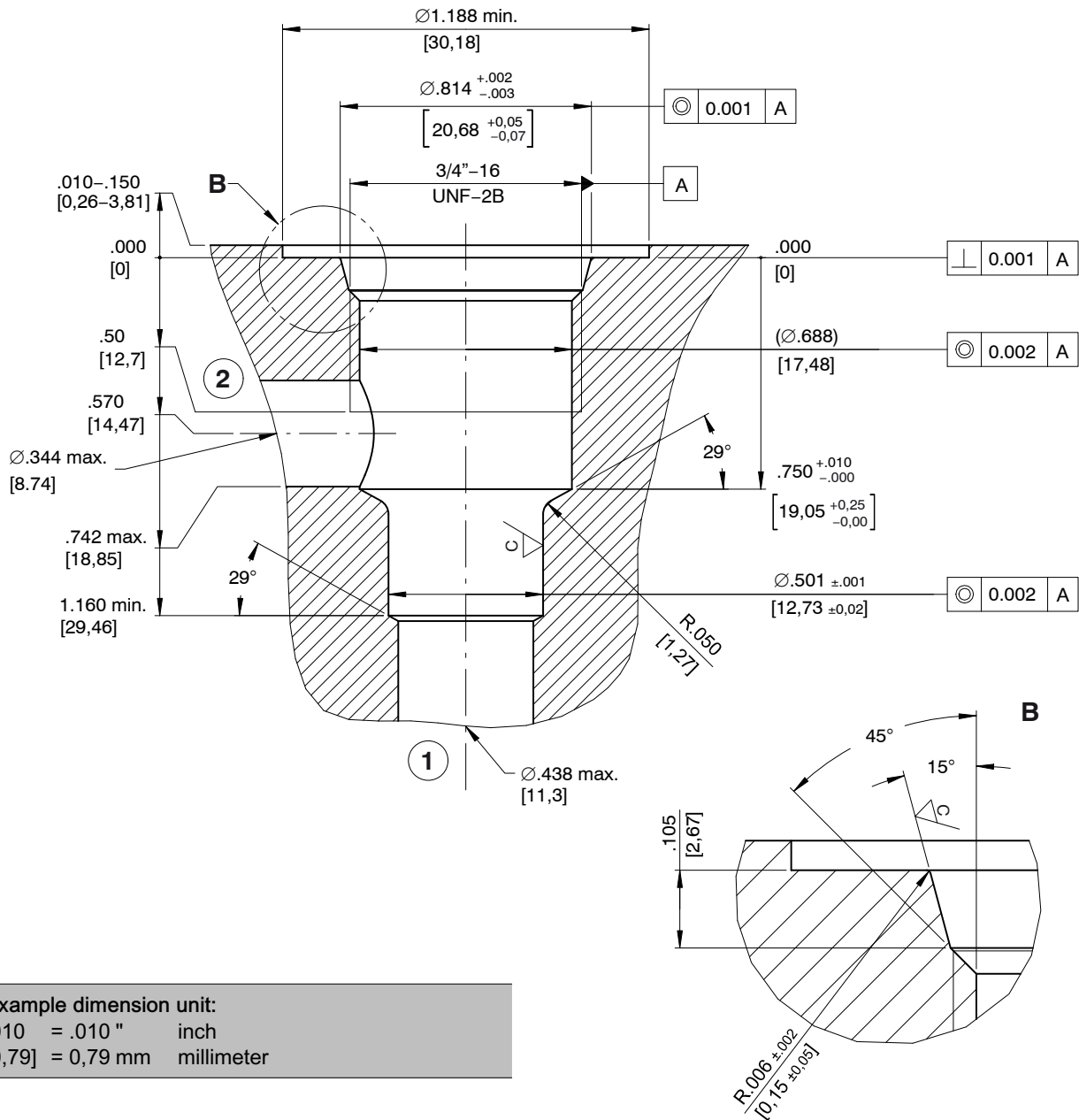

Example dimension unit:
 .010 = .010" inch
 [0,79] = 0,79 mm millimeter

Dimension Tolerances	
Unless otherwise specified	
0.000	$\pm .005''$
0.00	$\pm .010''$
Angles	$\pm 1/2^\circ$

Surface roughness		
	∇C	∇D
Ra	45 μin	125 μin
	(1.15 μm)	(3.2 μm)
	∇D	Unless otherwise specified

1 Related data sheets

Reference	(Old no.)	Description
520-P-000050		The form-tool selling programme
520-P-000111	(0-011.1)	Line-mounting body, 8 Series – 2-way

info.el@bucherhydraulics.com

www.bucherhydraulics.com/commoncavity

© 2016 by Bucher Hydraulics, Inc., 2545 Northwest Parkway, Elgin, Illinois 60124, USA

All rights reserved.

Data is provided for the purpose of product description only, and must not be construed as warranted characteristics in the legal sense. The information does not relieve users from the duty of conducting their own evaluations and tests. Because the products are subject to continual improvement, we reserve the right to amend the product specifications contained in this catalogue.

Classification: 430.Cavity....