

## 3 Ways/2 Pos. Cartridge Spool Valve, SAE 12 / NG 10

$Q_{max} = 16.0 \text{ gpm [60 l/min]}$ ,  $p_{max} = 5000 \text{ psi [350 bar]}$   
direct acting, with solenoid operation  
Series ESDV-12-3...

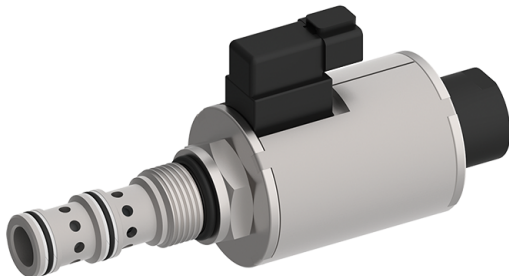

- Compact construction for cavity type C1230
- A low power consumption
- Continuous-duty cycle
- Low heat rise
- Hardened precision fitted spool & sleeve provides consistent high performance and long life
- High performance solenoid valve
- All exposed parts with zinc plating
- High pressure wet-armature solenoids
- Interchangeable IP rated solenoid coils & terminations options available
- The slip-on coil can be rotated, and it can be replaced without opening the hydraulic envelope
- Various plug-connector systems and voltages are available
- Can be fitted in a line-mounting body
- Replaces EMDV-12-3...

### 1 Description

These direct acting 3 way / 2 pos solenoid operated spool valves, series ESDV-12-3... are size SAE 12 / NG 10, pressure balanced screw-in cartridges with a 1-1/16-12 UN mounting thread. When the solenoid coil is de-energized, this valve allows flow between port 2 and 1 with port 3 blocked. When solenoid coil is energized, the spool is shifted and blocks port 1 (spool A and C) respectively 2 (spool B and D) and permits flow between the other 2 ports. Valves with spool type C or D are shifting in closed transition. Valves with spool A or B are shifting in open transition. Maximum inlet capacity of flow and pressure are allowed at port 3 or port 2. Port 1 is designed to be connected to tank and

therefore maximum inlet pressure is limited to 3200 psi at port 1. Manual override operation: Press and hold on the small plunger which is located on top of the valve with a similar object smaller than 0.180" diameter. All external parts of this cartridge valve are zinc plated and are thus suitable for use in harsh operating environments. The slip-on coils can be replaced without opening the hydraulic envelope and can be positioned at any angle through 360°. If you intend to manufacture your own cavities or are designing a line-mounting installation, please refer to the section "Related data sheets".

### 2 Symbol (ISO 1219)

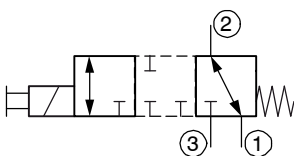

ESDV-12-3A...

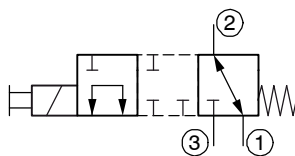

ESDV-12-3B...

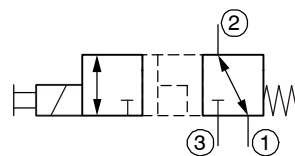

ESDV-12-3C...

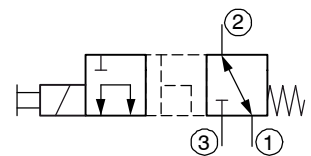

ESDV-12-3D...

### 3 Technical data

General characteristics	Description, value, unit
Designation	3 ways / 2 positions cartridge spool valve
Design	direct acting, with solenoid operation
Mounting method	screw-in cartridge 1-1/16-12 UN-2B

Reference: 520-P-106030-EN-01

General characteristics	Description, value, unit
Size	SAE 12 / NG 10 for cavity type C1230
Weight	3.5 lbs [1.6 kg]
Mounting attitude	unrestricted (preferably vertical, coil down)

Hydraulic characteristics	Description, value, unit
Maximum operating pressure - ports 3, 2 - port 1	5000 psi [350 bar] 3200 psi [220 bar]
Maximum flow rate - ports 3, 2 - port 1	16 gpm [60 l/min] 11 gpm [41 l/min]
Internal leakage	25 cu.in/min by 3200 psi [410 ml/min by 220 bar] 35 cu.in/min by 5000 psi [574 ml/min by 350 bar]
Hydraulic fluid	HL and HLP mineral oil to DIN 51 524; for other fluids, please contact BUCHER
Hydraulic fluid temperature range NBR: Viton:	-13 °F ... +180 °F [-25 °C ... +80 °C] + 5 °F ... +250 °F [-15 °C ... +120 °C]
Viscosity range	10...500 mm <sup>2</sup> /s (cSt), recommended 15...250 mm <sup>2</sup> /s (cSt)
Minimum fluid cleanliness Cleanliness class to ISO 4406 : 1999	class 20/18/15

Electrical characteristics	Description, value, unit
Supply voltage	12 V DC, 24 V DC, 103 V DC, 206 V DC note: • for AC applications an external rectifier circuit is required • the effective voltage in AC (with external rectifier circuit) is 11% higher than the rated DC voltage: 103 VDC → 115 V AC (respectively 206 V DC → 230 V AC) • above 48 V a ground connection to the metal housing of the coil is required
Supply voltage tolerance	± 10 %
Ambient temperature range	-22 °F ... +140 °F [-3 °C ... +60 °C]
Power consumption at max. control current 12 V DC, 24 V DC 103 V DC <sup>2)</sup> , 206 V DC <sup>2)</sup>	Nominal power consumption: 27 W 31 VA <sup>3)</sup>
Switching time	45 ... 100 ms (solenoid ON) 20 ... 100 ms (solenoid OFF) These times are strongly influenced by fluid pressure, flow rate and viscosity, as well as by the dwell time under pressure.
Relative duty cycle	100 %
Protection class to ISO 20 653 / EN 60 529	IP 65 / IP 67 / IP 69K, see "Ordering code" (with appropriate mating connector and proper fitting and sealing)
Electrical connection	2-pin square plug to ISO 4400 / DIN 43 650 (standard) <sup>3)</sup> for other connectors, see "Ordering code"

Note:

<sup>2)</sup> for AC applications an external rectifier circuit is required. ATTENTION: The effective voltage in AC (with external rectifier circuit) is 11% higher than the rated DC voltage.

<sup>3)</sup> above 48 V a ground connection to the metal housing of the coil is required

## 4 Performance graphs

measured with oil viscosity 33 mm<sup>2</sup>/s (cSt)

$\rho = f(l)$  Pressure adjustment characteristic – ESDV-12-3A

$\Delta p$  [psi (bar)]

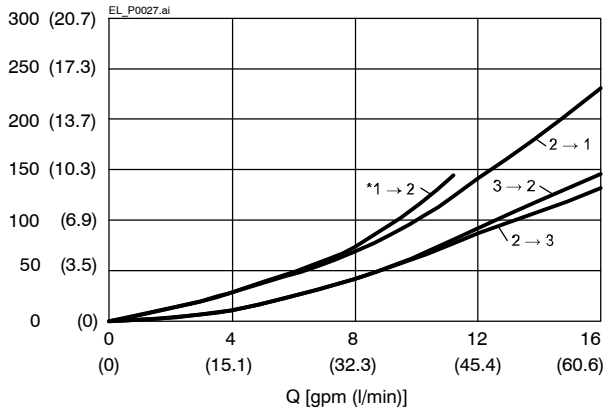

$\rho = f(l)$  Pressure adjustment characteristic – ESDV-12-3B

$\Delta p$  [psi (bar)]

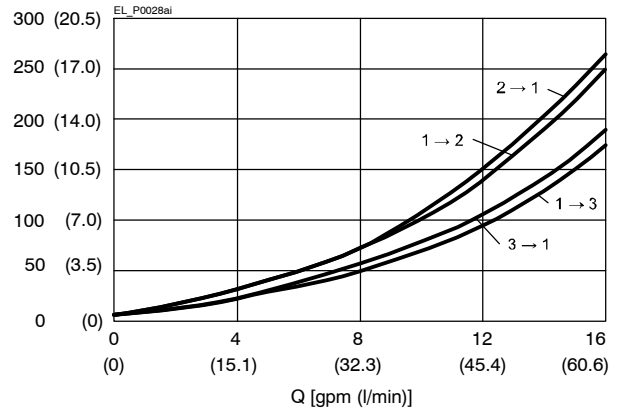

$\rho = f(l)$  Pressure adjustment characteristic – ESDV-12-3C

$\Delta p$  [psi (bar)]

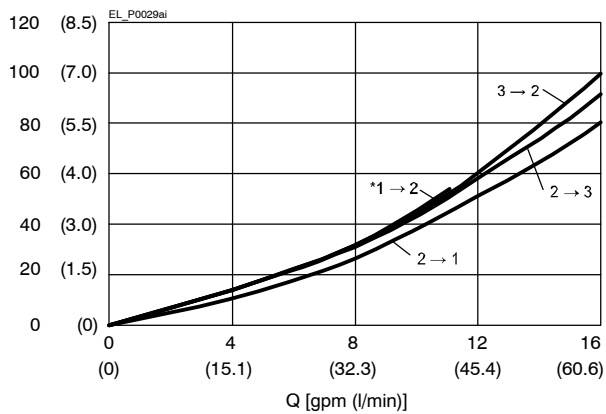

$\rho = f(l)$  Pressure adjustment characteristic – ESDV-12-3D

$\Delta p$  [psi (bar)]

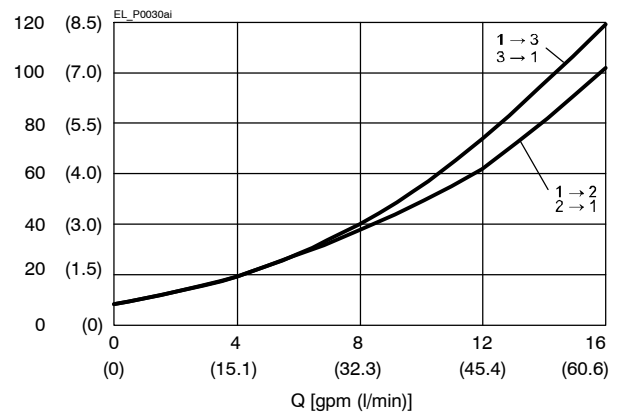

**IMPORTANT!**

\* port 1 inlet flow limited to 11 gpm (41.6 l/min)

## 5 Dimensions & sectional view

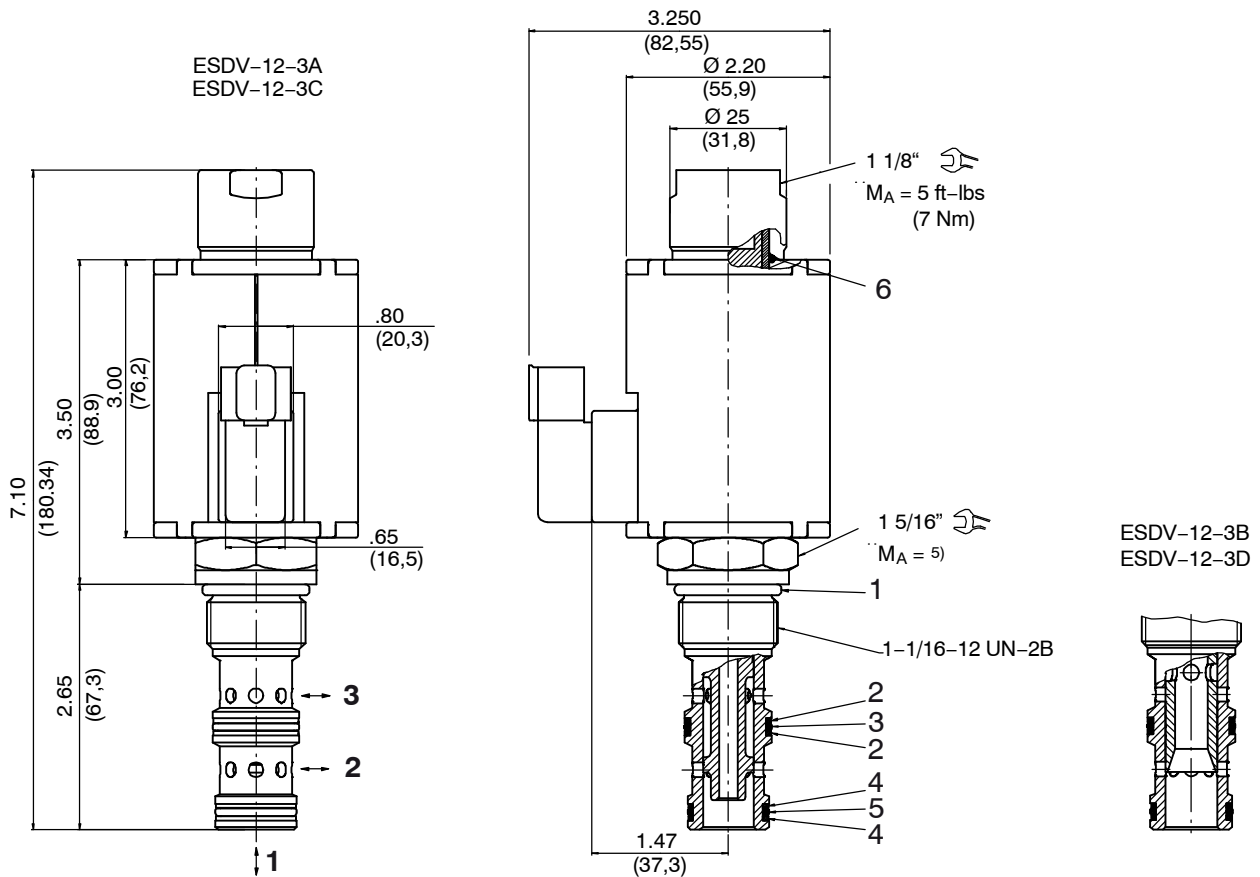

Tightening torque  $M_A$  <sup>5)</sup>

Cavity type	C1230
When fitted in aluminium	55...60 ft-lbs (74 - 81 [Nm])
When fitted in steel	70...75 ft-lbs (95 - 101 [Nm])

## 6 Installation information



### IMPORTANT!

When fitting the cartridges, use the specified tightening torque. No adjustments are necessary, since the cartridges are set in the factory.



### ATTENTION!

Only qualified personnel with mechanical skills may carry out any maintenance work. Generally, the only work that should ever be undertaken is to check, and possibly replace, the seals. When changing seals, oil or grease the new seals thoroughly before fitting them.

Seal kit NBR no. SKN-1232-S1 <sup>4)</sup>

Item	Qty.	Description	
1	1	O-ring no. 912 Ø 0.924 x 0.116 B-90	Inch
2	2	Backup ring 0.830 x 0.053 x 0.048 FI0751	Inch
3	1	O-ring no. 019 Ø 0.801 x 0.070 B-70	Inch
4	2	Backup ring 0.768 x 0.053 x 0.048 FI0751	Inch
5	1	O-ring no. 018 Ø 0.739 x 0.070 B-70	Inch
6	1	O-ring no. 020 Ø 0,864 x 0,070 V70	Inch



### IMPORTANT!

<sup>4)</sup> Seal kit with FKM (Viton) seals, no. SKV-1232-S1

## 7 Ordering code

Ex. ESDV - 12 - X - 3A - X - 24 D -

ESDV	=	directional valve, spool-type, direct acting
12	=	size SAE 12 / NG 10
N	=	NBR (Nitrile) seals (standard)
V	=	FKM (Viton) seals (special seals - please contact BUCHER)
3A	=	A Spool 3-way/2-position (closed transition)
3B	=	B Spool 3-way/2-position (closed transition)
3C	=	C Spool 3-way/2-position (open transition)
3D	=	D Spool 3-way/2-position (open transition)
0	=	cartridge only
04BA	=	line-mounting body G 1/2" -14 BSPP aluminum
04BS	=	line-mounting body G 1/2" -14 BSPP steel
06BA	=	line-mounting body G 3/4" -14 BSPP aluminum
06BS	=	line-mounting body G 3/4" -14 BSPP steel
10TA	=	line-mounting body SAE-10 aluminum
10TS	=	line-mounting body SAE-10 steel
12TA	=	line-mounting body SAE-12 aluminum
12TS	=	line-mounting body SAE-12 steel
...	=	voltage e.g. 24 (24 V)
D	=	current DC
		mating plug not supplied:
T	=	Deutsch axial plug connection DT04-2P (IP 67/69K) <sup>1)</sup>
TR	=	Deutsch axial plug connection DT04-2P (with protection diode, IP 67/69K) on request <sup>1)</sup>
S	=	1/4" Spade Terminals connection
F	=	flying leads (18 inch, [450 mm])
H	=	ISO 4400 / DIN 43 650 connection (IP 65)

Note:

<sup>1)</sup> only up to 48 V

## 8 Related data sheets

Reference	(Old no.)	Description
520-P-000050		Form tools
520-P-000330	(0-033.0)	Cavity type C1230
520-P-001020		Coils D 2.2/.875 for screw-in cartridge valves
520-P-000331	(0-033.1)	Line-mounting body, 12 series – 3 way

info.el@bucherhydraulics.com

www.bucherhydraulics.com/commoncavity

© 2017 by Bucher Hydraulics, Inc., 2545 Northwest Parkway, Elgin, Illinois 60124, USA

All rights reserved.

Data is provided for the purpose of product description only, and must not be construed as warranted characteristics in the legal sense. The information does not relieve users from the duty of conducting their own evaluations and tests. Because the products are subject to continual improvement, we reserve the right to amend the product specifications contained in this catalogue.

Classification: 430.300.330.305.315.380