

Check valve

Spring loaded check

$Q_{\max} = 90 \text{ l/min}$, $p_{\max} = 350 \text{ bar}$

plate type

Type series: RVE-G-10-...



- Screw-in cartridge valve
- Virtually leak-proof in closed condition
- High pressure rating
- Particularly suitable for use as a make-up check valve
- Optional metered flow in the no-flow direction
- Variant with metallic sealing edge without soft seal, thus not depending on temperature and pressure fluid.

Description

The RVE series plate-type check valve is virtually leak-free. Due to its fast response, it can be used as a make-up check valve. Orifices in the valve plate allow simple "metered check" functions. The spring-loaded poppet-type check valve in plate design is very robust, extremely leak-proof and insensitive to contamination.

Valve seat, poppet and body are hardened. The properties of the sealing faces have been enhanced by precision mechanical processing. The valves prevent flow in the screw-in direction (B to A) and open in the opposite direction. The valve is available in nominal sizes 04, 06, 08, 10, 16 and 25.

Symbol

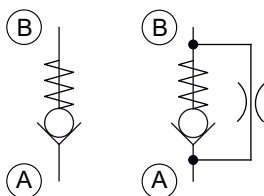

Technical Data

General Characteristics	Description, value, unit
Function group	Check valve
Function	Spring loaded check
Design	Screw-in cartridge valve
Characteristic	plate type
Construction size	nominal size 10
Thread size	G 1/2"
Mounting attitude	unrestricted
Weight	0.022 kg
Tightening torque steel	Version OR: 30 Nm / Version DK: 40 Nm

Hydraulic Characteristics	Description, value, unit
Maximum operating pressure	350 bar
Maximum flow rate	90 l/min
Nominal flow rate	50 l/min
Flow direction	see symbol
Hydraulic fluid	HL and HLP mineral oil according to DIN 51 524; other fluids on request!
Minimum fluid temperature	- 30 °C
Maximum fluid temperature	+ 80 °C
Viscosity range	10 ... 500 mm ² /s (cSt)
Minimum fluid cleanliness (cleanliness class according to ISO 4406:1999)	class 20/18/15
Opening pressure	0.2...0.3 / 1.0 / 2.0 bar

i **NOTE!**
For other values please contact Bucher Hydraulics.

Performance graphs

measured with oil viscosity 33.0 mm²/s (cSt)

$\Delta p = f(Q)$ Pressure drop-flow rate characteristic

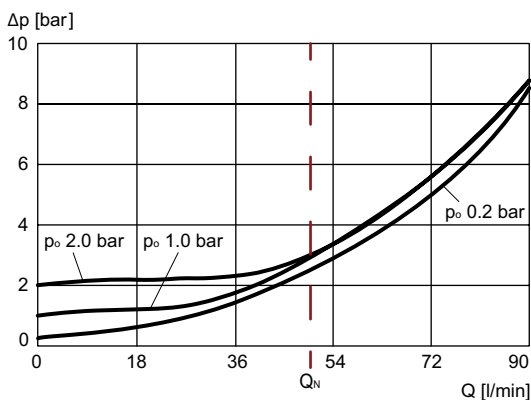

Dimensions and sectional view

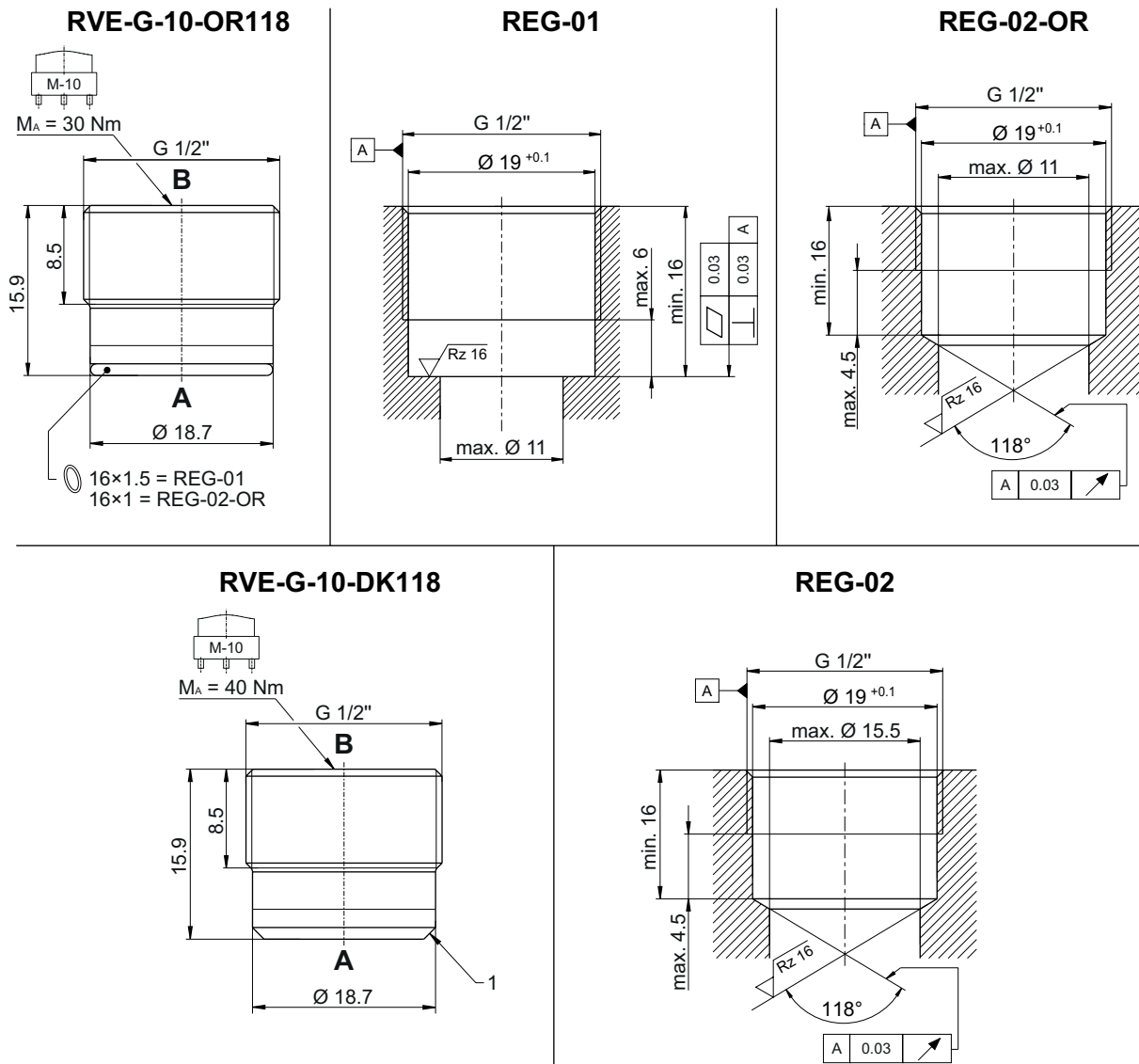

RVE-G-10 = check valve / screw-in cartridge valve

REG-01 = dimension of the cavity for screw-in cartridge RVE-G-10

REG-02 = dimension of the cavity for screw-in cartridge RVE-G-10

REG-02-OR = dimension of cavity type for screw-in cartridge RVE-G-10

1 = sealing edge for metal-to-metal sealing

The dimensions specified apply to the mounted state.

Installation information

**NOTE!**

When fitting the screw-in cartridge valve, use the specified tightening torque. The value can be found in the chapter technical data. Orifices or nozzles are to be placed after the check valve. If this is not possible, a right-angled bore must be designated between the check valve and the nozzle. (see data sheet 170-P-059000). Recommendation: before installing the valve, fit the O-ring in the cavity. Suitable fitting tools are available at Bucher Hydraulics (see data sheet 170-P-051600).

**ATTENTION!**

When fitting the valve, make sure that it is firmly seated on the sealing surface and that it is not deformed by the use of excessive force.

Application Notes

**NOTE!**

The maximum operating pressure must not be exceeded even when pressure peaks occur. In applications such as accumulator circuits, where sudden pressure can be applied to the valve in the free-flow direction, ensure that the specified flow ratings are not exceeded. Buyers bear the sole responsibility for ensuring that the valve is suitable for their applications and must be substantiated by trials or testing, if necessary.

**ATTENTION!**

The valves are only suitable for pressure relief in the opening direction to a limited extent. (if necessary, please consult Bucher Hydraulics).

Ordering code

Ex. RVE - G - 10 - 03 - D10 - _ - _

- RVE = check valve, plate design, screw-in cartridge valve
- G = whitworth pipe thread G 1/2"
- 10 = nominal size 10, Q_{Nominal} 50 l/min
- 03 = opening pressure 0.2 up to 0.3 bar
- 1 = opening pressure 1.0 bar
- 2 = opening pressure 2.0 bar
- (blank) = no orifice bore
- D04 = orifice bore with diameter 0.4 mm
- D05 = orifice bore with diameter 0.5 mm
- D06 = orifice bore with diameter 0.6 mm
- D08 = orifice bore with diameter 0.8 mm
- D10 = orifice bore with diameter 1.0 mm
- D12 = orifice bore with diameter 1.2 mm
- D15 = orifice bore with diameter 1.5 mm
- D20 = orifice bore with diameter 2.0 mm
- D25 = orifice bore with diameter 2.5 mm
- (blank) = NBR (nitril-butadien-rubber / BUNA) seals (*standard*)
- V = FKM (fluorocarbon rubber / VITON) seals
- (blank) = O-Ring sealing, valve face flat, cavity type REG-01
- OR118 = O-Ring sealing, valve face with 118° phasing, cavity type REG-02-OR
- DK118 = metallic sealing edge, cavity type REG-02

Related data sheets

Reference	Description
170-P-051600	Mounting tool for series RKVE... and RV...
170-P-059000	Using nozzles or orifices before a Check Valve