

Lock valve

Spring-loaded non-return valve

$Q_{\max} = 35 \text{ l/min}$, $p_{\max} = 350 \text{ bar}$

ball type

Type series: RVVL-G-08-...



- Pipe line mounting valve
- Compact construction
- High pressure rating
- Very small pressure rise
- High opening pressures
- Usable as preload valve

Description

The RVVL series check valve is specially designed for line-mounting installations. It is characterized by high opening pressures and incredibly low pressure rise. This is reflected in the flat performance graph. The valve can be used as a preload valve. The spring-loaded spherical poppet-type check valve is very robust, extremely leak-proof, and insensitive to contamination. The valve seat, poppet, and body are hardened. The

properties of the sealing faces have been enhanced by precision mechanical processing. The valves prevent flow in the screw-in direction (B to A) and open in the opposite direction. The check valve is supplied completely mounted in a hexagonal body. The valve is available in nominal sizes 04, 06, 08, 10, 16, 25, 32 and 40.

Symbol



Technical data

General characteristics	Description, value, unit
Function group	Lock valve
Function	Spring-loaded non-return valve
Design	Pipe line mounting valve
Characteristic	ball type
Construction size	nominal size 08
Thread size	G 3/8"
Mounting attitude	unrestricted
Weight	0.17 kg
Tightening torque steel	15 Nm

Hydraulic characteristics	Description, value, unit
Maximum operating pressure	350 bar
Maximum flow rate	35 l/min
Nominal flow rate	30 l/min
Flow direction	see symbol
Hydraulic fluid	HL and HLP mineral oil according to DIN 51 524; other fluids on request!
Minimum fluid temperature	- 30 °C
Maximum fluid temperature	+ 80 °C
Viscosity range	10 ... 500 mm ² /s (cSt)
Minimum fluid cleanliness (cleanliness class according to ISO 4406:1999)	class 20/18/15
Opening pressure	4 / 6 / 8 / 10 / 12 bar

i **NOTE!**
For other values please contact Bucher Hydraulics.

Performance graphs

measured with oil viscosity 33.0 mm²/s (cSt)

$\Delta p = f(Q)$ Pressure drop-flow rate characteristic

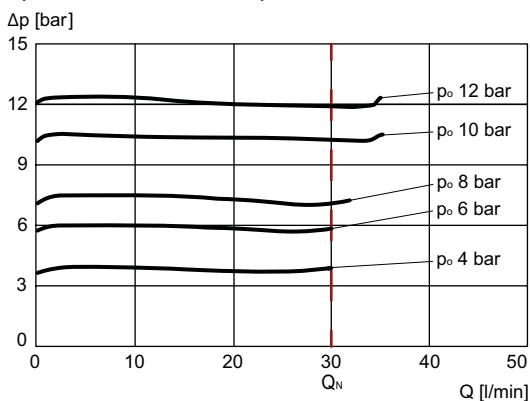

Dimensions and sectional view

RVVL-G-08 check valve for line-mounting installations

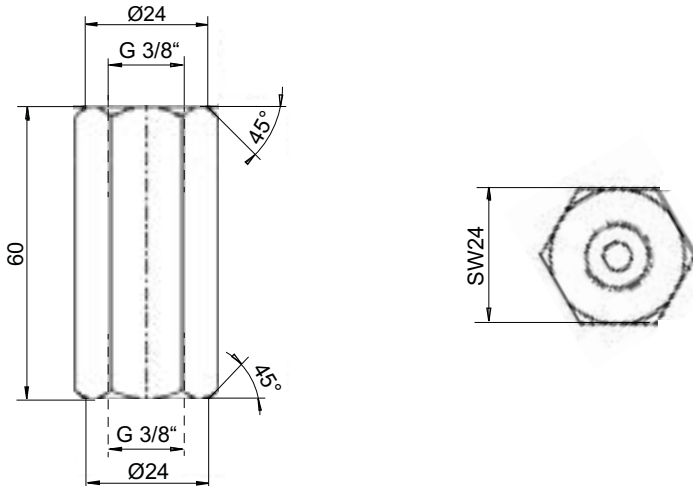

Installation information



NOTE!

When fitting the pipe line mounting valve, use the specified tightening torque. The value can be found in the chapter technical data.



NOTE!

The maximum operating pressure must not be exceeded even when pressure peaks occur. In applications such as accumulator circuits, where sudden pressure can be applied to the valve in the free-flow direction, ensure that the specified flow ratings are not exceeded. Buyers bear the sole responsibility for ensuring that the valve is suitable for their applications and must be substantiated by trials or testing, if necessary.



ATTENTION!

The valves are only suitable for pressure relief in the opening direction to a limited extent. (if necessary, please consult Bucher Hydraulics).

Ordering code

RVV - L - G - 08 - 06 -

RVV = Preload check valve, spherical poppet design

L = Pipe line mounting valve

G = Whitworth pipe thread G3/8"

08 = Nominal size 08, Q_{nominal} 30 l/min

4 = Opening pressure 4 bar

6 = Opening pressure 6 bar

8 = Opening pressure 8 bar

10 = Opening pressure 10 bar

12 = Opening pressure 12 bar

blank = NBR (Nitrile) seal (standard)

V = FKM (Viton) seal