

Stacking 2/2 Directional Valve, ISO size 3 Solenoid Controlled, Seated Design Series SWRA22..ECA...-6

- 315 bar, 80 l/min
- With two-stage, solenoid controlled 2/2 cartridge valve, type WRA22...-10
- 'No flow' pilot stage
- All ports rated to 315 bar
- Corrosion protection: body zinc-phosphated, exposed cartridge parts zinc-plated

- With ISO 4401 / CETOP R35H size 3, NFPA D03, DIN 24 340 A6 interface

1. Description

Series SWRA22 ...-6 stack valves are two-stage units, the pilot and main stages both being of seated design. They are equipped with the 2/2 sole-

noid cartridge valve type WRA22G...-10 or WRA22O...-10. The valve design features screw-in cartridges, thus ensuring straightforward, very user-friendly maintenance. Sealing at the manifold-side ('bottom') interface is by means of O-rings that are fitted in counterbores in the stacking body.

2. Symbols

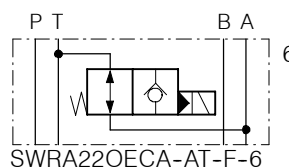
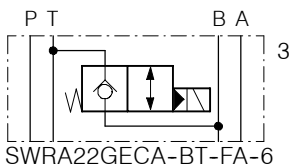
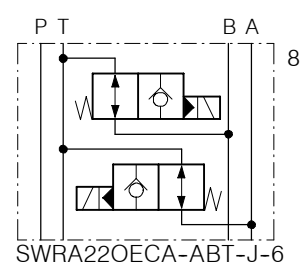
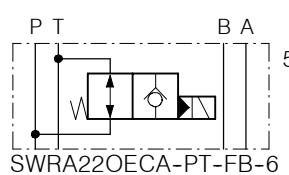
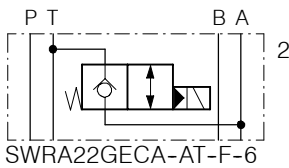
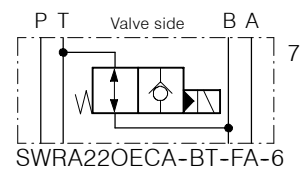
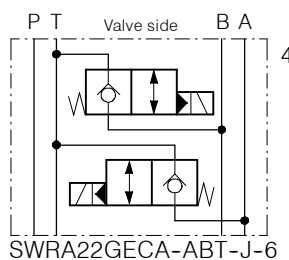
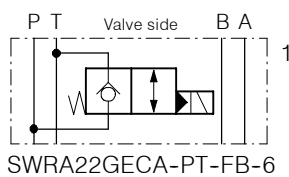

3. Dimensions

Symbols 1 ... 3
Symbols 5 ... 7

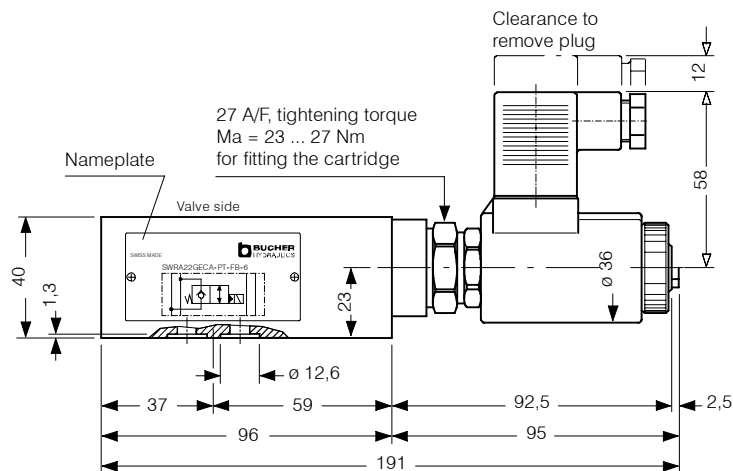

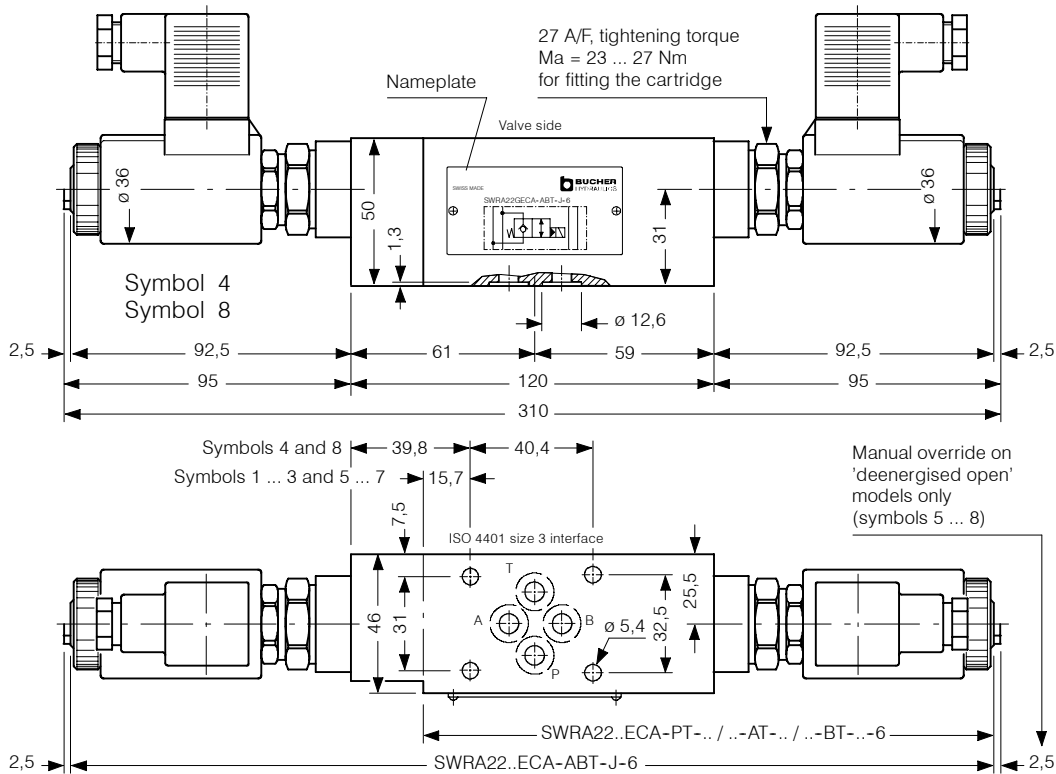

4. Schematic section

showing the relevant ports
Ex. SWRA22..ECA-PT-FB-6 ...

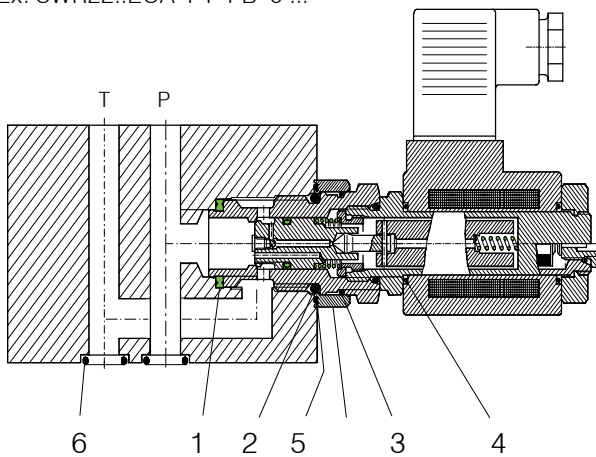

Seal kit no. DS-311, comprising:

| Itm. | Qty. | Description | Size |
|------|------|----------------|----------------------|
| 1 | 1 | Seal ring | Ø 22,1 / 16,5 x 2,5 |
| 2 | 1 | O-ring no. 117 | Ø 20,29 x 2,62 N90 |
| 3 | 1 | O-ring no 020 | Ø 21,95 x 1,78 N90 |
| 4 | 2 | O-ring | Ø 16,00 x 2,00 Viton |
| 5 | 1 | O-ring | Ø 27,00 x 1,50 N75 |
| 6 | 4 | O-ring no. 012 | Ø 9,25 x 1,78 N90 |

1 Sealkit for SWRA22..ECA-PT/AT/BT-...-6 ...

2 Sealkits for SWRA22.. ECA-ABT-J-6 ...

5. Installation and servicing

All installation and servicing must be carried out with care, and by qualified personnel only. At installation, make sure that the valve interface aligns with the interface of the mating surface and

do not confuse the directional valve ('top') and manifold ('bottom') faces of the valve. When changing seals, the new seals should be thoroughly oiled or

greased before they are fitted. When fitting the cartridge, ensure that the seals are oiled or greased and use the specified tightening torque.

6. Ordering code

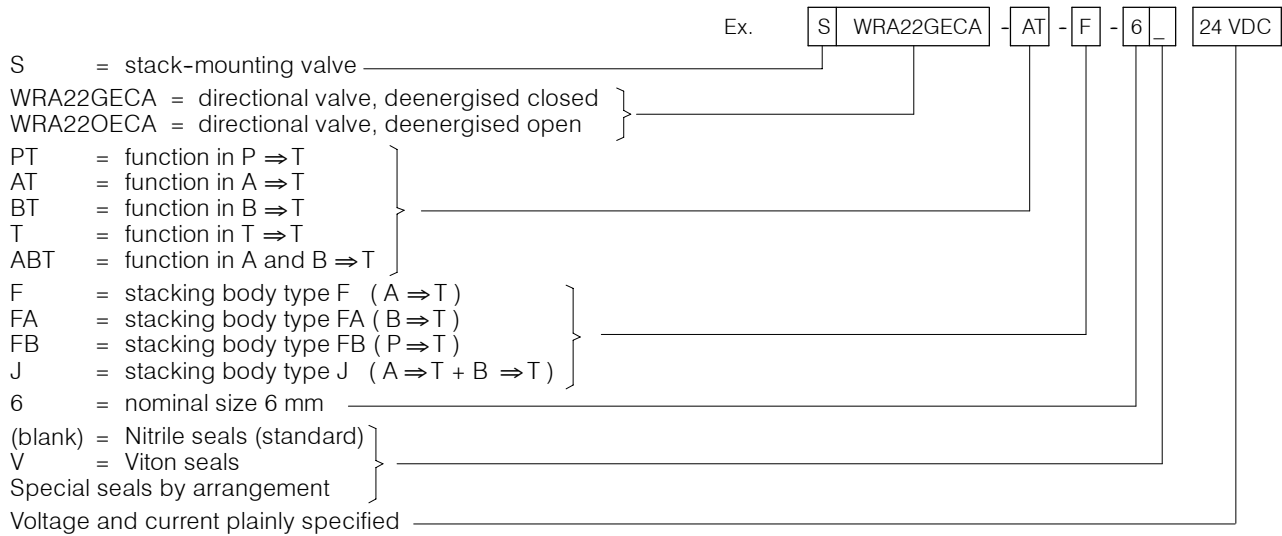

7. Related data sheets

| Old no. | New no. | |
|-----------|----------------|---|
| i - 00 | 400-P-010101-E | Table of interface equivalents |
| i - 31 | 400-P-030501-E | DIN 24 340 size A6 interface |
| W - 6.160 | 400-P-131120-E | 2/2 Solenoid Cartridge Valve WRA22 ...-10 |

info.ch@bucherhydraulics.com

www.bucherhydraulics.com

© 2015 by Bucher Hydraulics AG Frutigen, CH-3714 Frutigen

All rights reserved.

Data is provided for the purpose of product description only, and must not be construed as warranted characteristics in the legal sense. The information does not relieve users from the duty of conducting their own evaluations and tests. Because the products are subject to continual improvement, we reserve the right to amend the product specifications contained in this catalogue.