

General information

Cavity

Type series: REG-03-25

Dimensions and sectional view

Beispiel für die Masseinheit:
Example for the dimensional units:
30.5 = 30.5 mm millimeter

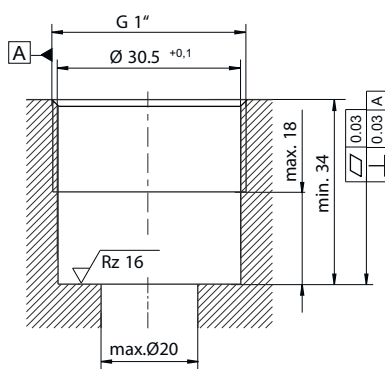

Installation information



ATTENTION!

You must maintain the dimensional and diametral tolerances. To ensure trouble-free operation of the check valves, we strongly recommend that pilot drilling, boring and cavity thread-cutting are always performed in one setup.



NOTE!

Cavity type to factory standard.

info.de@bucherhydraulics.com

www.bucherhydraulics.com

© 2025 by Bucher Hydraulics Dachau GmbH, 85221 Dachau, Germany

All rights reserved.

Data is provided for the purpose of product description only, and must not be construed as warranted characteristics in the legal sense. The information does not relieve users from the duty of conducting their own evaluations and tests. Because the products are subject to continual improvement, we reserve the right to amend the product specifications contained in this catalogue.